

Panel Installation



Oreco Systems®
Incorporated

Before Installing Panel

1. *Read all instructions before proceeding with the installation. Improper installation may void warranties.*
2. Inspect your order for completeness and inspect each component for shipment damage. If something is missing or damaged, you will need to contact your supplier to obtain replacements.
3. Check to be sure the instructions and items supplied comply with state and local regulations.
4. A qualified electrician must be employed to install and service the panel and ancillary wiring. The equipment must be installed in compliance with the National Electric Code, as well as state and local codes.

814 AIRWAY AVENUE
SUTHERLIN, OREGON
97479-9012

TELEPHONE:
(541) 459-4449

FACSIMILE:
(541) 459-2884

Placement of the Control Panel

5. Install the electrical control or alarm panel within view of the tank. The panel should be attached to a post or an exterior wall. Panels that contain motor contactors make a thumping sound, each time a pump is started or stopped. Therefore, these panels should not be mounted to an exterior wall unless it is in a location away from living areas, such as on a garage wall. If possible, position the panel in the shade to protect it from weather. Extreme temperatures can cause inconsistent performance of the electrical components. Locate the panel at a convenient height (usually about five feet above the ground) and where it will be accessible for maintenance.

Install Floats and Pumps

6. Install the electrical splice box(es) for the floats and pump(s) before installing the actual floats and pumping equipment. The splice box(es) are installed in the grommet(s) provided near the top of the riser.
7. Install the floats. Thread the float and pump cords through the cord grips into the PVC splice box, leaving adequate lengths of electrical cord coiled inside the riser to allow easy removal of the pump and float assembly. Do not remove the colored markers or the paper tags from the float cords, and do not try to thread the markers and tag through the cord grip. These should be left on the float cord, outside the splice box. Tighten the cord grips, using hand pressure or a wrench if necessary, until the cord will no longer move in the cord grip. If the cord grips are not tight enough, the seal will not be watertight, but overtightening may damage the cord or the cord grip, so use only as much force as necessary. Adequate lengths of cord should be left within the splice box to allow for easy removal for future disconnecting and re-splicing.
8. Run the wires from the control panel to the splice box. The wires can be brought through a conduit, or can be buried using suitable direct-burial wire. Conduit that enters the splice box must be sealed, even if the wires are direct-buried, to prevent the infiltration of water into the splice box. Use an electrically approved sealant to plug the wires coming in through the conduit hub. The number of wires required depends on the control panel and the number of floats and pumps used. This can be determined by consulting the Float Arrangement diagram appropriate for the control panel and float arrangement being used.

Wire should be sized at 14 AWG for the floats. Refer to Figure 1 to determine the proper size for the pump wires. When calculating wire size, the length and size of the branch circuit wires from the service entrance panel to the pump control panel must also be taken into account. Wire that's too small can cause an excessive voltage drop and poor pump performance.

Wires should be color coded or otherwise marked to aid in wiring the control panel. Drawing EIN-SB-SB-1 lists recommended colors for each of the wires. Colors may refer to either the color of the wire's insulation, the color of a tag, or the color of an electrical tape marker.

9. All splices made in the splice box should use waterproof wire nuts or butt connectors and heat shrink tubing. The splices must be waterproof! Splices that are not waterproof may cause a malfunction of the pump controls if water should leak into the splice box. Refer to Drawing EIN-SB-SB-1 for instructions on making waterproof splices. Refer to the appropriate Float Arrangement diagram for instructions on how to connect the floats together.

Connect Control Panel

10. Connect the wires coming from floats to the terminals in the control panel. Refer to the appropriate Float Arrangement diagram for the correct terminal connections.

11. Connect the wires coming from the pump(s) to the pump terminals. Refer to the panel wiring diagram for the correct terminal connections.

12. Connect the incoming power to the panel. Power to the panel must be appropriate to the control panel and pump motor (i.e. 120VAC, single phase for a 120 VAC motor, 240 VAC single phase for a 240 VAC motor, etc.) Insure that the panel is properly grounded and that the fuse or breaker and wire size, from the main power panel and to the pump, are sized correctly. Separate circuits for the pump controls and each of the pump motors is recommended. Note: Voltage for the controls in the panel is always 120VAC, although the pump voltage may be 120VAC or 240 VAC.

13. Use 60° minimum CU conductors only. Torque the terminal blocks to 15 LB-IN and the ground lugs to 45 LB-IN. Torque the circuit breakers to 20 LB-IN for 14-10 AWG wire, 25 LB-IN for 8 AWG wire, and 27 LB-IN for 6-4 AWG wire.

14. When power is applied to the control panel, the wires to the pump may be energized. Do not service the pump or any electrical wiring in the pump vault without disconnecting the power at the circuit breaker and the fuse. The pump vault area is a hazardous area, and may contain explosive gases. Take appropriate precautions before working in the pump vault.

15. If you have any questions please contact Orenco Systems, Inc.

Figure 1. Recommended Breaker & Wire Size

<u>Pump Motor Size</u>	<u>Breaker size</u>	<u>Wire Size</u>	<u>Max Distance*</u>
120 VAC 1/2 hp	20 amp	10 AWG	105 ft
240 VAC 1/2 hp	15 amp	14 AWG	161 ft
3/4 hp	20 amp	14 AWG	130 ft
1 hp	20 amp	12 AWG	172 ft
1 1/2 hp	20 amp	12 AWG	126 ft

* This is the maximum distance from this subpanel to the pump motor for the recommended wire size. Distance is based on 3% maximum voltage drop from subpanel to load at maximum recognized pump motor amps at 75° C.

Panel Wiring Diagram Model S1



Oreco Systems®
Incorporated

814 AIRWAY AVENUE

SUTHERLIN, OREGON

97479-9012

TELEPHONE:

(541) 459-4449

FACSIMILE:

(541) 459-2884

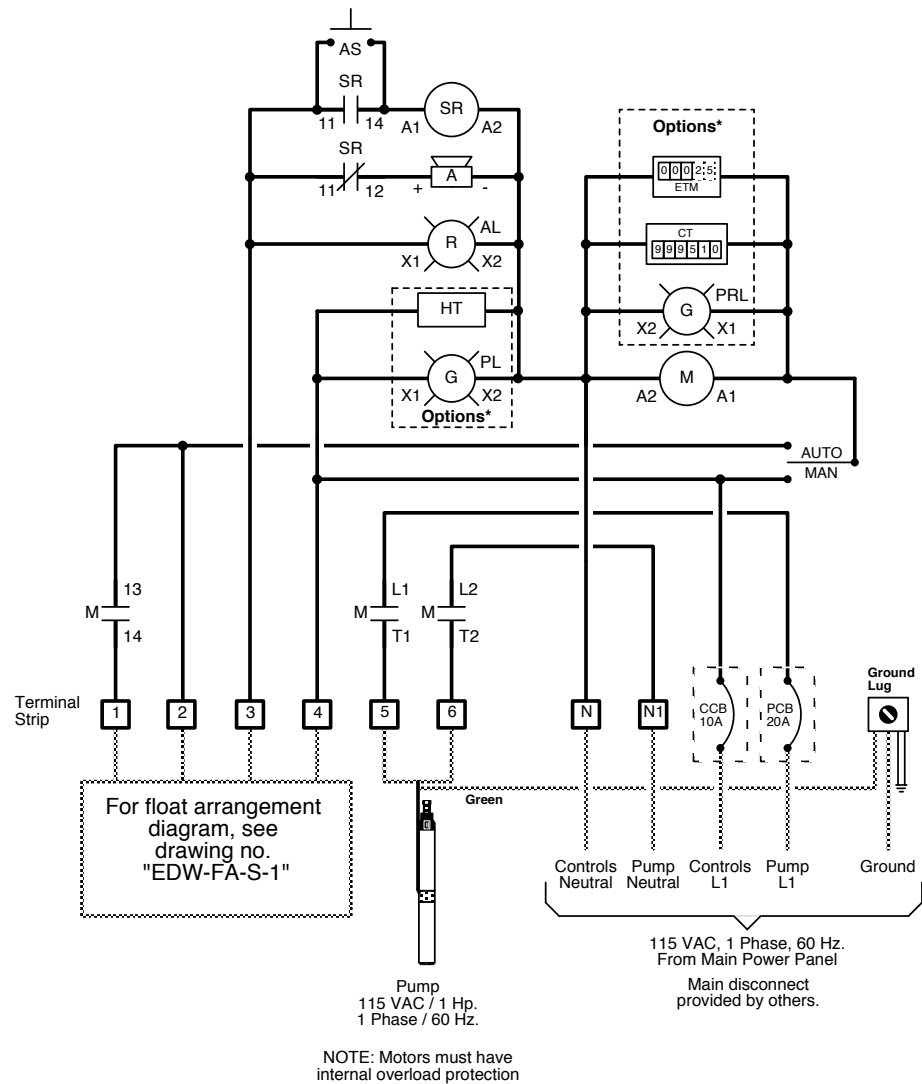

Simplex Operation

High Level Alarm: This float activates the alarm light and audible alarm when lifted. The audible alarm may be silenced by pressing the illuminated PUSH TO SILENCE button on the front of the control panel. The alarm light will remain on until the float is lowered.

Pump On: This float turns on the pump when lifted. The pump will continue to run until the pump off float is lowered.

Pump Off: This float shuts off the pump when lowered.

Key

- = Factory Wire
- - - = Field Wire
- · - = Alternate Field Wire
- A = Audio Alarm, 115 VAC
- AL = Alarm Light
- AS = Audio Silence Switch
- CCB = Controls Circuit Breaker
- M = Motor Contactor
- PCB = Pump Circuit Breaker
- SR = Silence Control Relay
- TL = Terminal Link

*Options

- CT = Cycle Counter
- ETM = Elapsed Time Meter
- HT = Heater
- PL = Power Light
- PRL = Pump Run Light

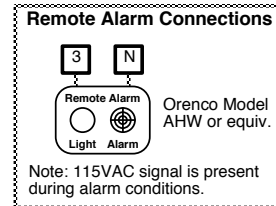

Power Wiring Options

Two Circuits

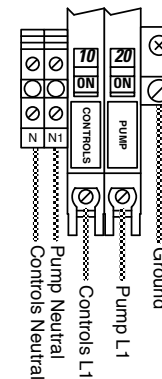

Factory default.
Wire as shown.

One Circuit

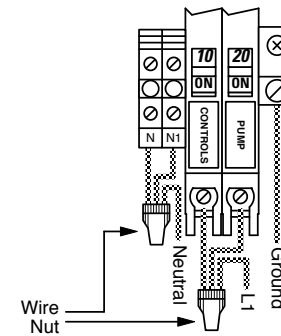

Use one wire nut to connect the pole of the pump circuit breaker together with the controls breaker and with the incoming L1 power line. Use another wire nut to connect the neutral block of the pump with the controls neutral block and with the incoming neutral line.

Splice Box Wiring Diagram



Oreco Systems®
Incorporated

814 AIRWAY AVENUE

SUTHERLIN, OREGON

97479-9012

TELEPHONE:



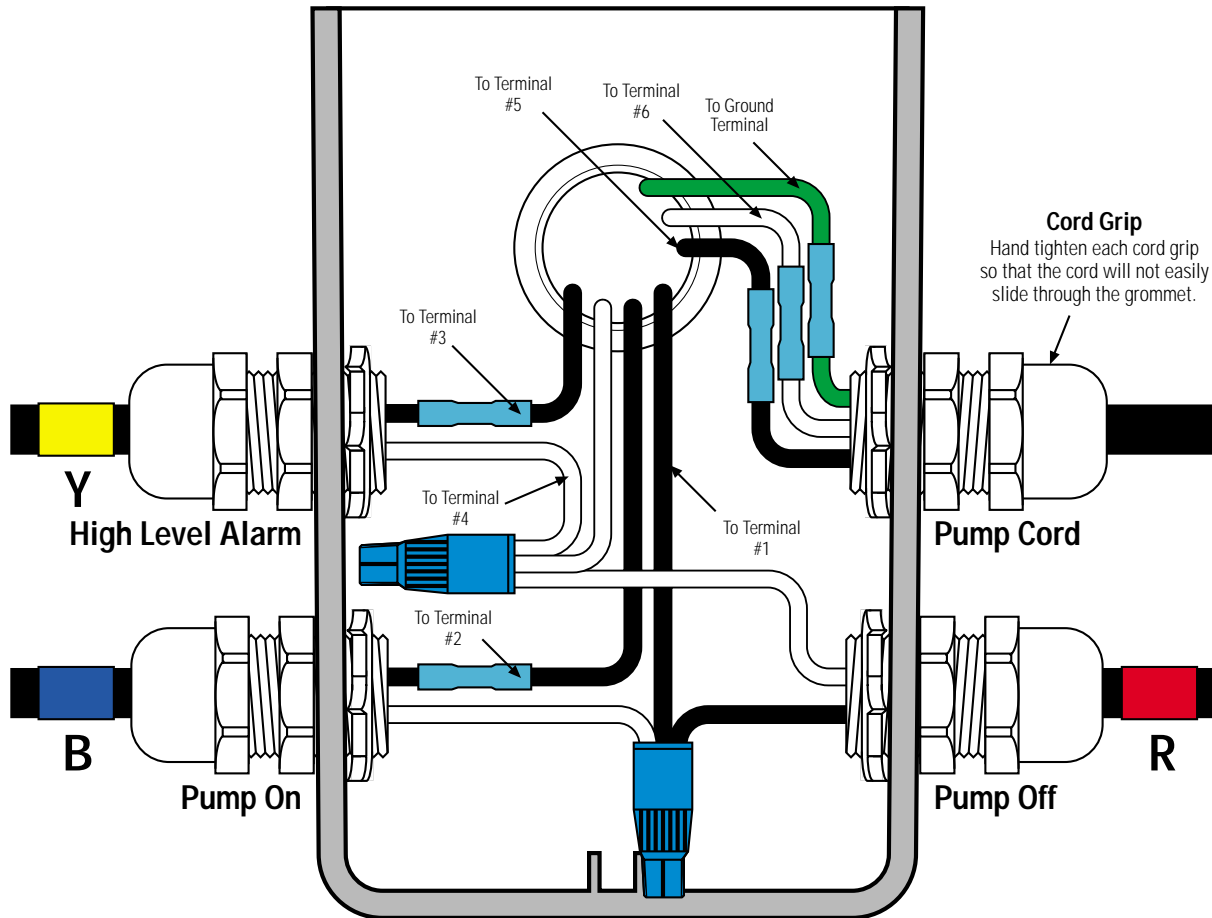

(541) 459-4449

FACSIMILE:

(541) 459-2884

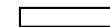

Key

-  Black Wire
-  White Wire
-  Green Wire
-  Waterproof Wire Nut
-  Heat Shrink & Butt Connector *

* Refer to drawing EIN-SB-SB-1 for splicing instructions.

Float Tag Colors

- Y** - Yellow
- P** - Purple
- B** - Blue
- G** - Green
- R** - Red
- O** - Orange
- E** - Grey
- W** - White

Note: Multi-function floats will have more than one marker

Attention: Failure to follow splicing instructions will void warranty

Control Panel Series

S

Float Function Color Code

YBR

Splice Box Model

SB4

Drawing No.

EDW-SB-S-2

EDW-SB-S-2
Rev 1.1 ©04/23/96

Splice Box Wiring Diagram

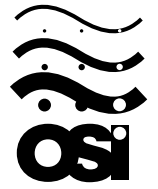

Oreco Systems®
Incorporated

814 AIRWAY AVENUE

SUTHERLIN, OREGON

97479-9012

TELEPHONE:



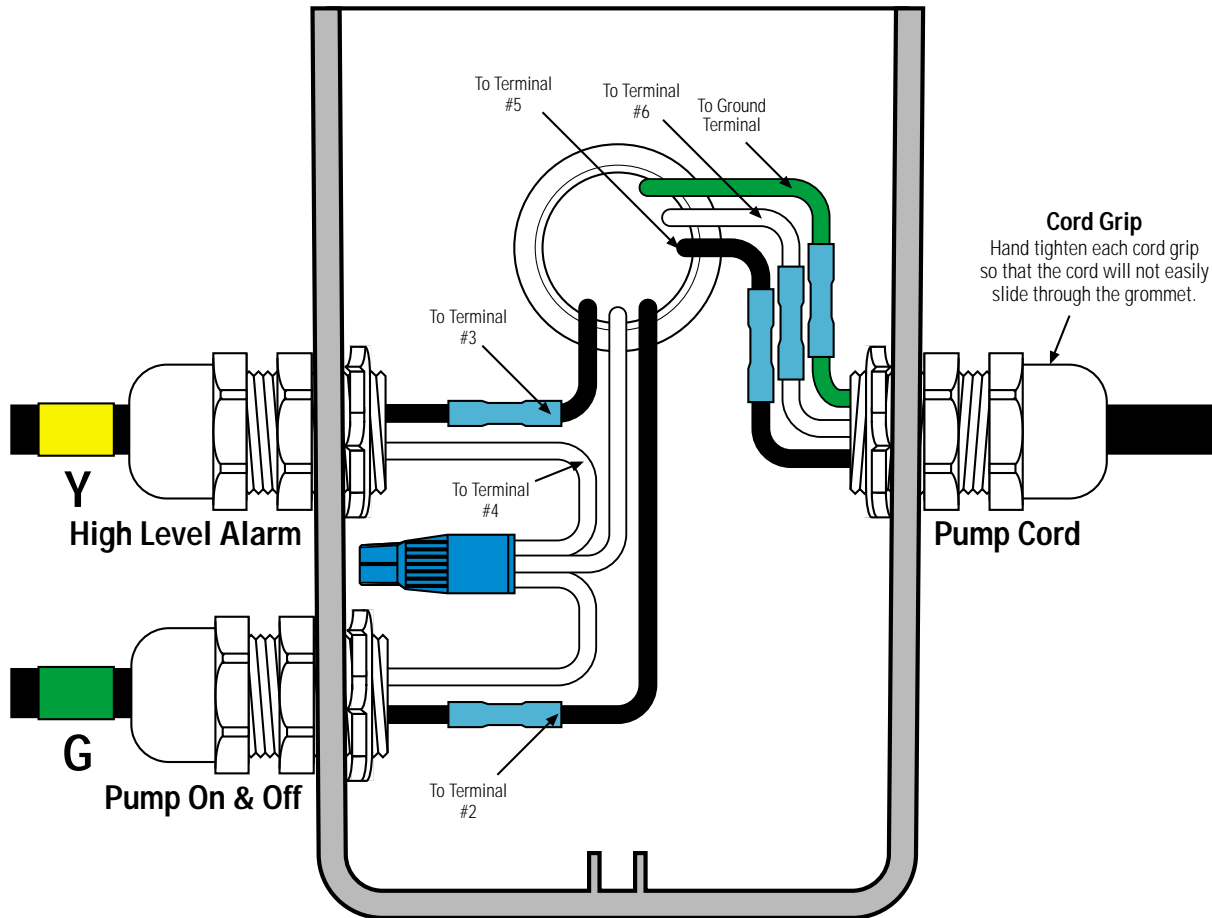

(541) 459-4449

FACSIMILE:

(541) 459-2884

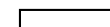

Key

-  Black Wire
-  White Wire
-  Green Wire
-  Waterproof Wire Nut
-  Heat Shrink & Butt Connector *

* Refer to drawing EIN-SB-SB-1 for splicing instructions.

Float Tag Colors

- Y** - Yellow
- P** - Purple
- B** - Blue
- G** - Green
- R** - Red
- O** - Orange
- E** - Grey
- W** - White

Note: Multi-function floats will have more than one marker

Attention: Failure to follow splicing instructions will void warranty

Control Panel Series

S

Float Function Color Code

YG

Splice Box Model

SB3

Drawing No.

EDW-SB-S-1

EDW-SB-S-1
Rev 1.2 ©04/29/98